



camphill
village
trust

TAURUS CRAFTS

paper plane

Follow these simple instructions to
create your own paper plane.

A LIFE OF OPPORTUNITY
EST.1954

Taurus Crafts, Lydney, GL15 6BU - 01594 844841
www.tauruscrafts.co.uk - enquire@tauruscrafts.co.uk

   @tauruscrafts #tauruscrafts



paper plane

1. First colour in the patterns on the piece of paper on the opposite page, or design your own.
2. Then follow these instructions, folding along the dotted lines.

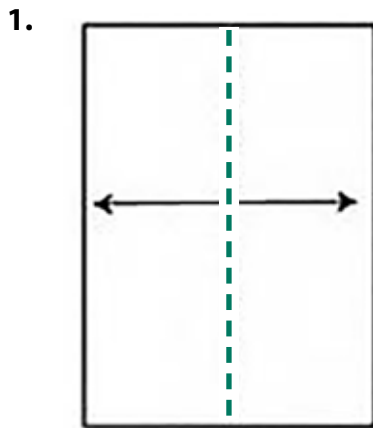

Fold piece of paper in half

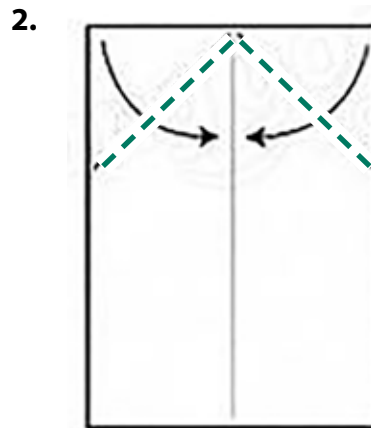

Unfold paper and fold in the top two corners

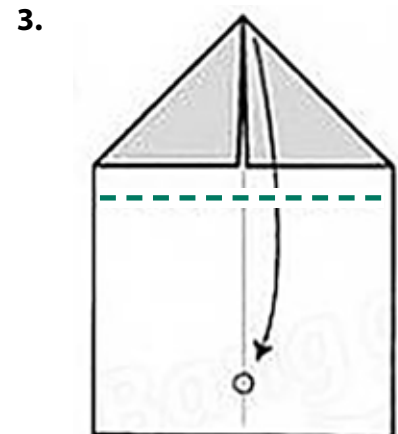

Take the top point and fold over. About 1-2cm from bottom edge.

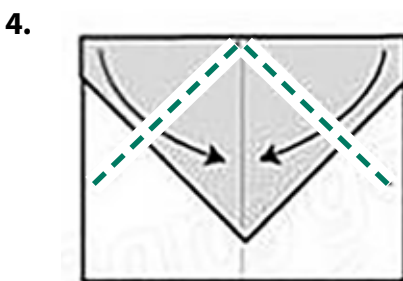

Fold the top two corners of the paper into the middle

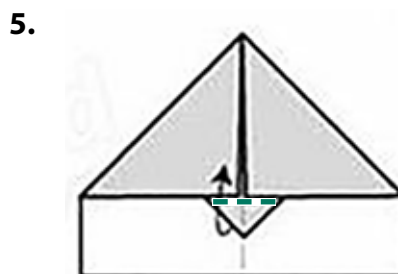

Fold small triangle point up

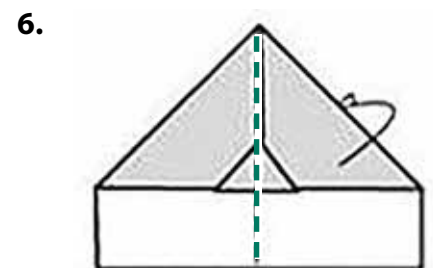

Fold paper in half, away from you

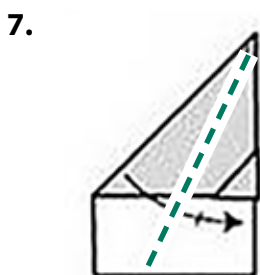

Fold to make wings

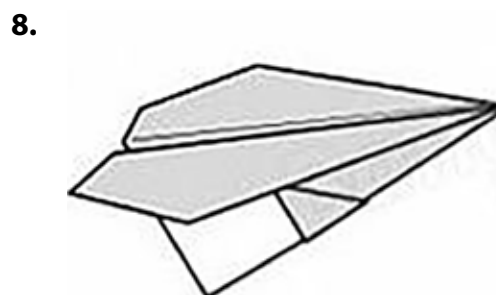

Now fly your plane

