



free printable activity sheets

Activity sheets

	page
Taurus maze	3
Colouring sheets	4-7
Word search	8
Crossword puzzle	9
Colour code maths	10
Silhouettes	11
Spot the items	13-14

Recipes

Easy oat cookies	16
Unicorn poo meringues	17
Raspberry flapjacks	18

Nature activities

	page
Bird spotting	20
Nature pictures	21-24
Instructions	16
Activity sheets	17-19

Paper plane

Instructions	26
Colouring sheet	27

Answers

29-31

A LIFE OF OPPORTUNITY
EST.1954

Taurus Crafts, Lydney, GL15 6BU - 01594 844841
www.tauruscrafts.co.uk - enquire@tauruscrafts.co.uk

   @tauruscrafts #tauruscrafts





activity sheets

A selection of fun activity sheets to have a go at, including word-searches, colouring sheets, a maze, spot the difference and more.

A LIFE OF OPPORTUNITY
EST.1954

Taurus Crafts, Lydney, GL15 6BU - 01594 844841
www.tauruscrafts.co.uk - enquire@tauruscrafts.co.uk

  [@tauruscrafts](https://twitter.com/tauruscrafts) [#tauruscrafts](https://www.facebook.com/tauruscrafts)



taurus maze

Using a pen, pencil or crayon, can you find your way to the bull in the centre of the maze?

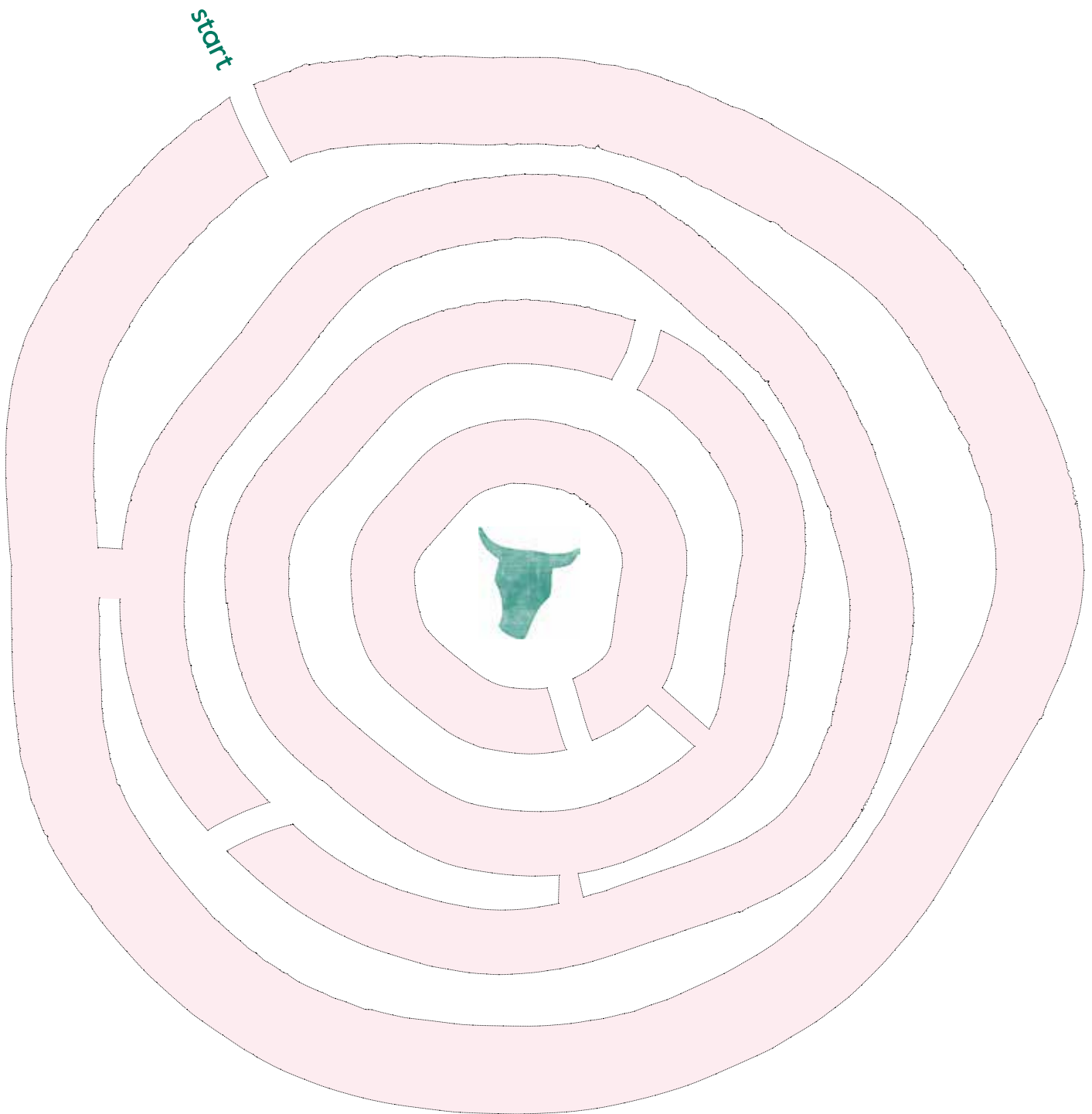

colouring

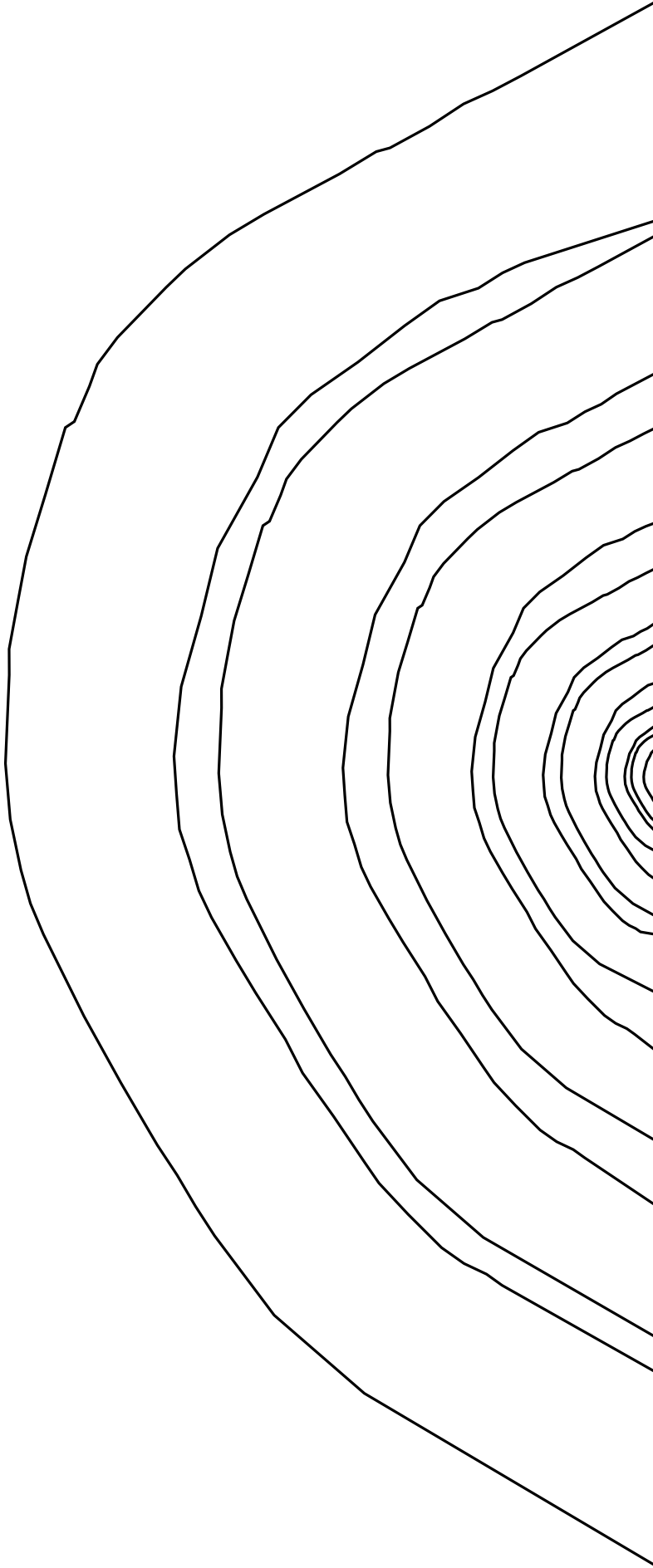

#staysofie

colouring

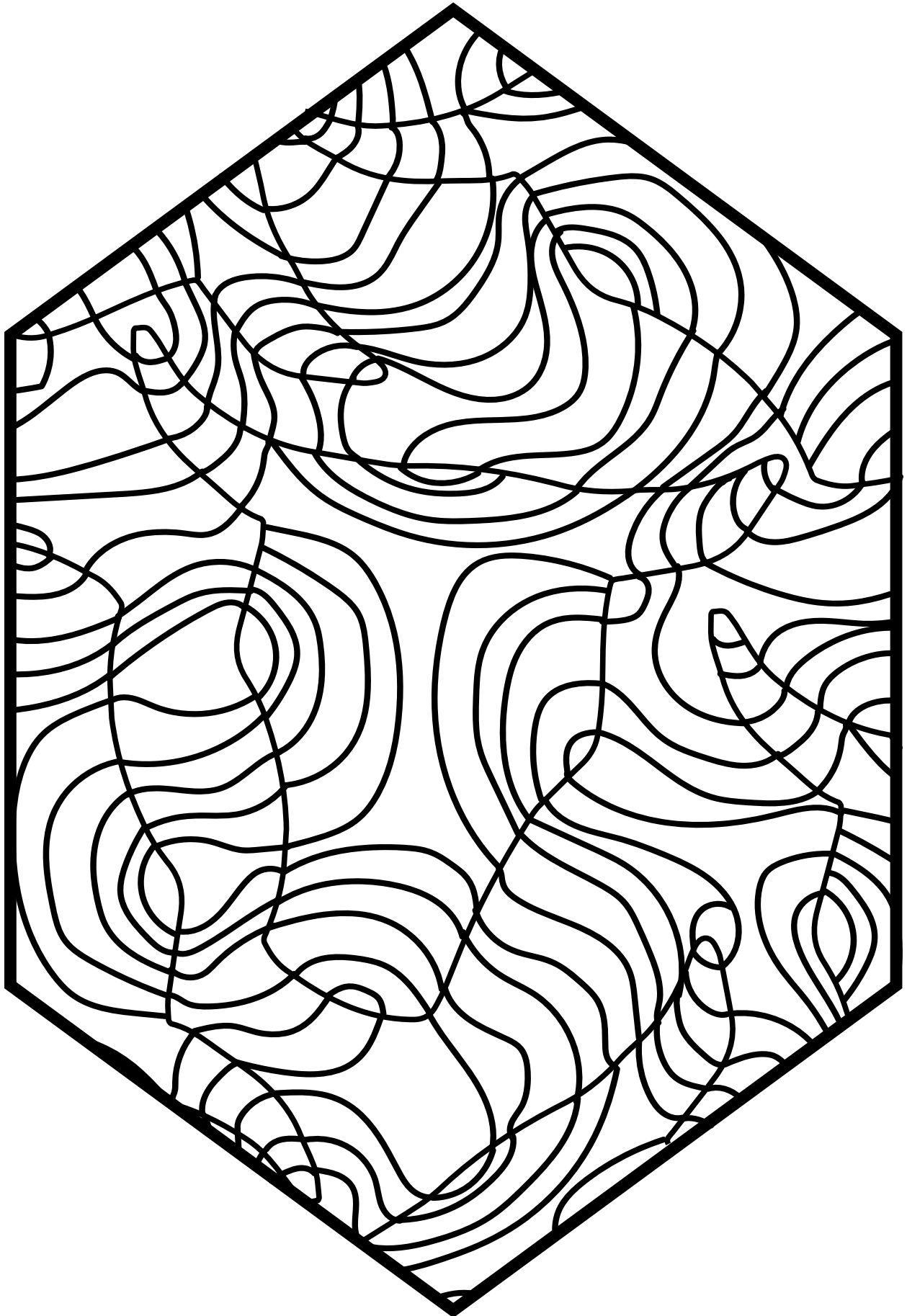

colouring

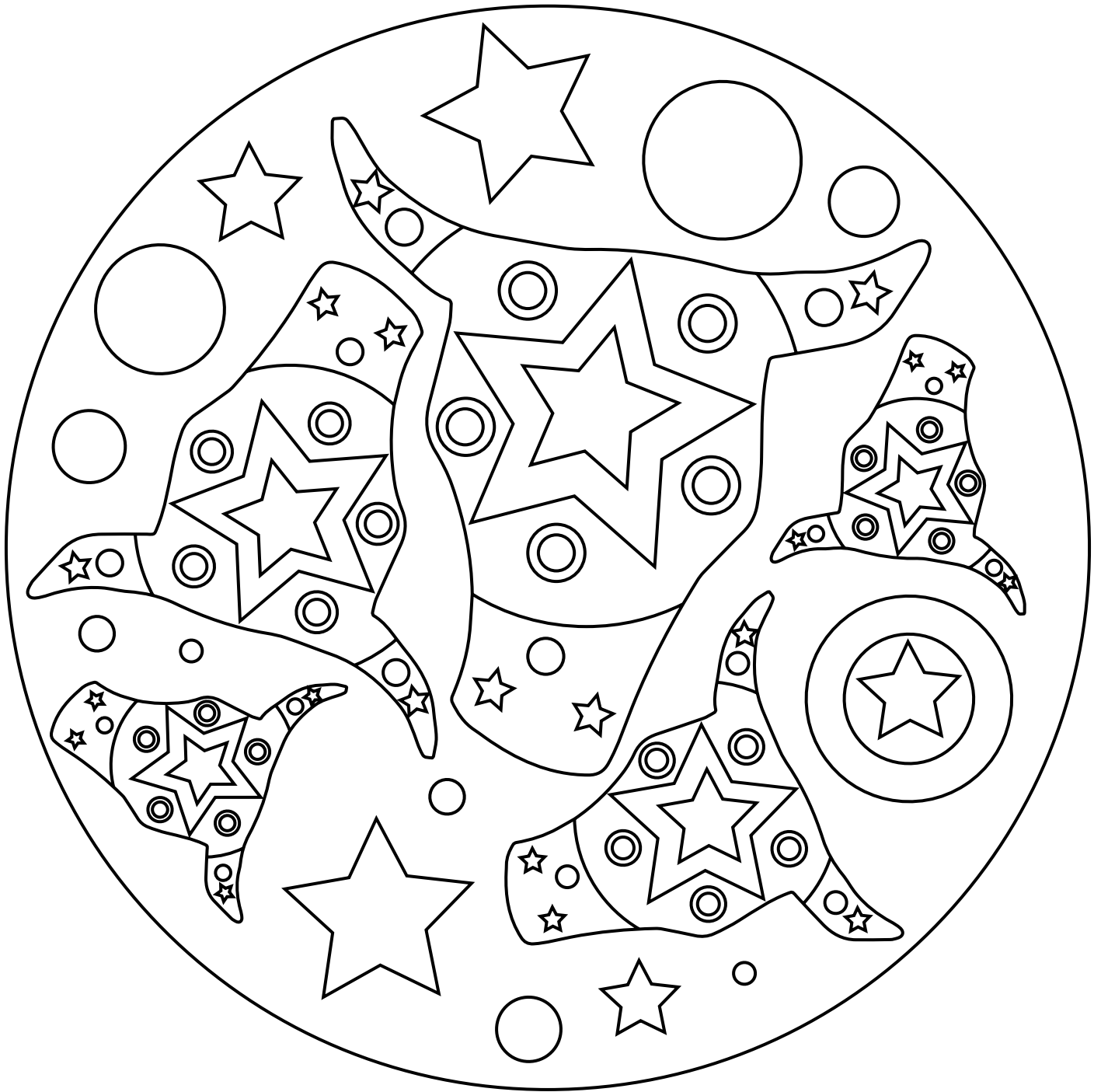

colouring

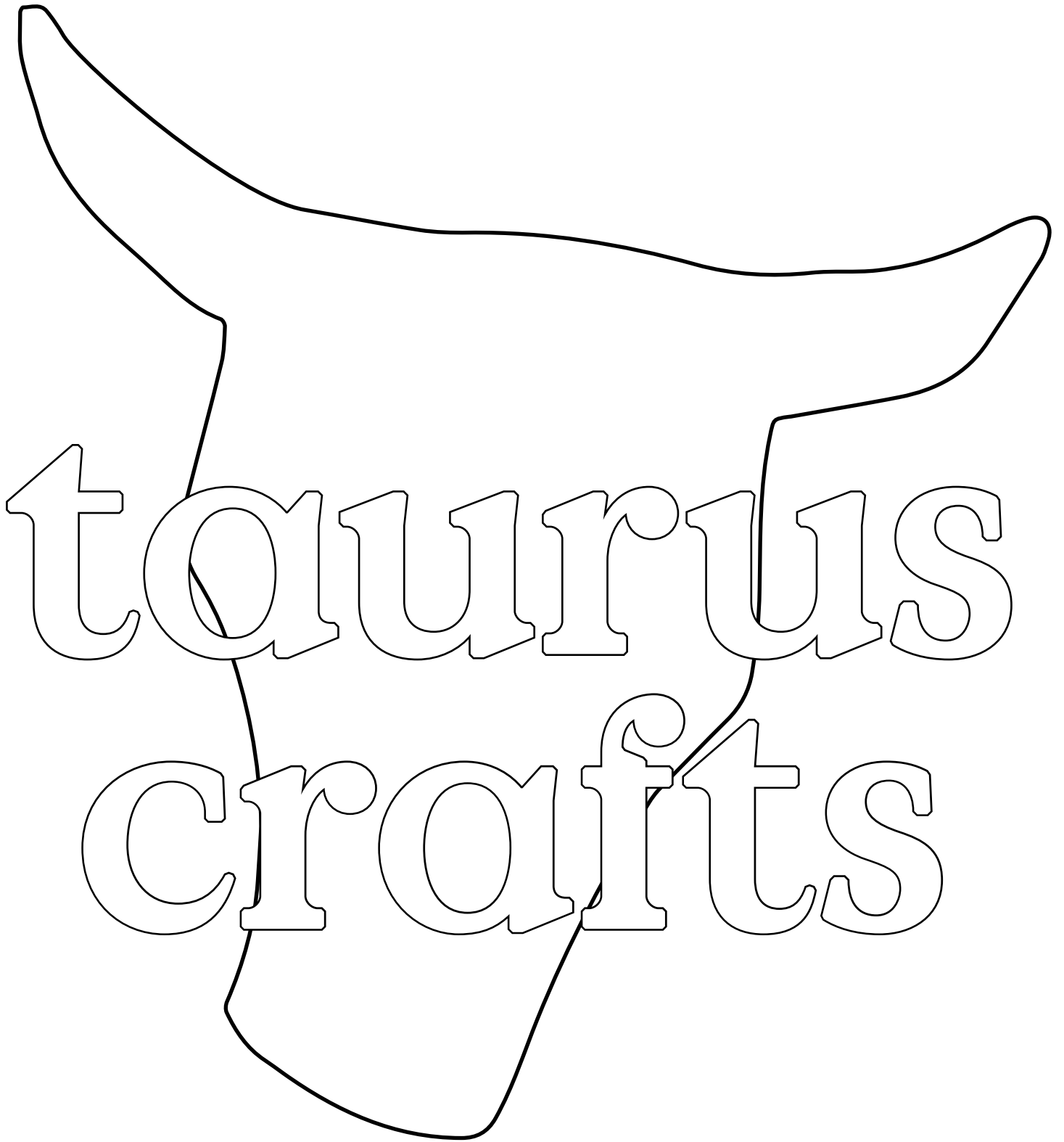

word-search

Can you find all of the hidden words in our taurus crafts themed word-search?

c e s u p p o r t u h m j s
a c o l o u r f e p k a r t
m a z e t q a i v j l r e o
p a m c t v i n e e w y t n
h c a a e s n g n w o r h e
i r k u r l b w t e k o i c
l a e j y u o b u l l s c a
l f r e c o w q k l v e a r
d t g l a s s f o e k u l v
c s g k u w c h a r i t y i
i l g r e e k o m y t h d n
t h u x c h o c o l a t e g
z a d e i k g i f t s h o p
t s v i b r a n t p k b i m

support

colour

charity

art

crafts

rainbow

jewellery

ethical

chocolate

stonecarving

glass

pottery

bull

greek

myth

mary rose

eco

giftshop

camphill

maze

event

vibrant

taurus

maker

crossword puzzle

Can you solve and complete the crossword puzzle?

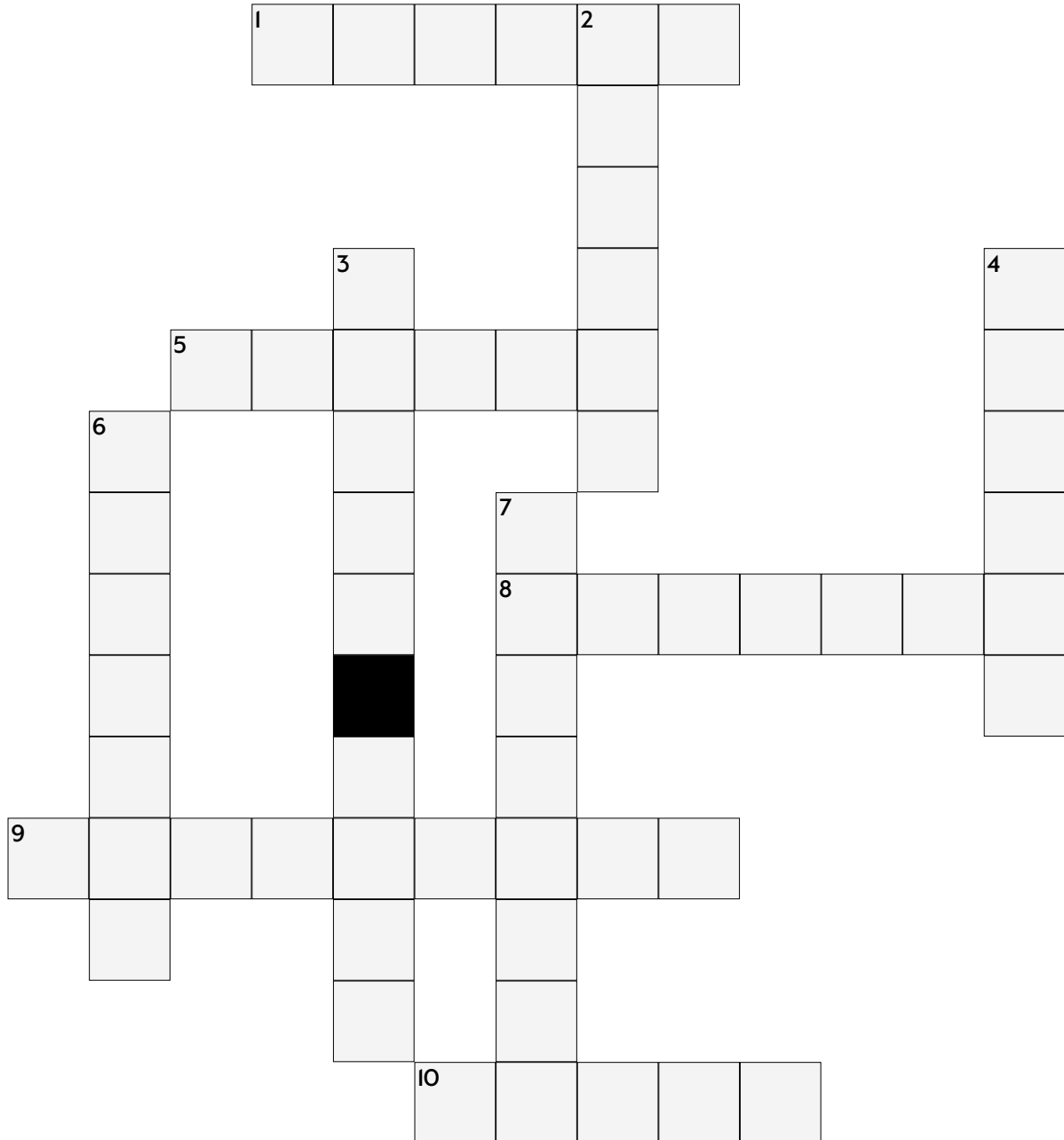

Across

1. Shape with four equal sides
5. Yellow fruit
8. The art of paper folding
9. Underwater vehicle
10. Funny entertainer

Down

2. Where planes take off and land
3. Common name for the UK flag
4. Largest country in the world
6. Eight legged sea animal
7. Building for poorly patients

colour code maths

Use the colour code to work out the answers to the code sums below.

$1 = \square$

$2 = \square$

$3 = \square$

$4 = \bigcirc$

$5 = \bigcirc$

$6 = \bigcirc$

$7 = \triangle$

$8 = \triangle$

$9 = \triangle$

$\bigcirc + \square = \square$

$\bigcirc + \triangle = \square$

$\triangle + \triangle = \square$

$\square + \bigcirc = \square$

$\bigcirc + \triangle = \square$

$\square + \bigcirc = \square$

$\square + \triangle = \square$

$\bigcirc + \square = \square$

$\square + \bigcirc = \square$

silhouettes

Can you work out which is the correct silhouette of the Minoan bull leaper?





spot the items

Help Leesa and King Arthur to find their missing items in the photographs.

A LIFE OF OPPORTUNITY
EST.1954

Taurus Crafts, Lydney, GL15 6BU - 01594 844841
www.tauruscrafts.co.uk - enquire@tauruscrafts.co.uk

   @tauruscrafts #tauruscrafts



lost butterflies



Leesa has lost her butterflies, can you find all five of the butterflies hidden in this image?

find the eggs

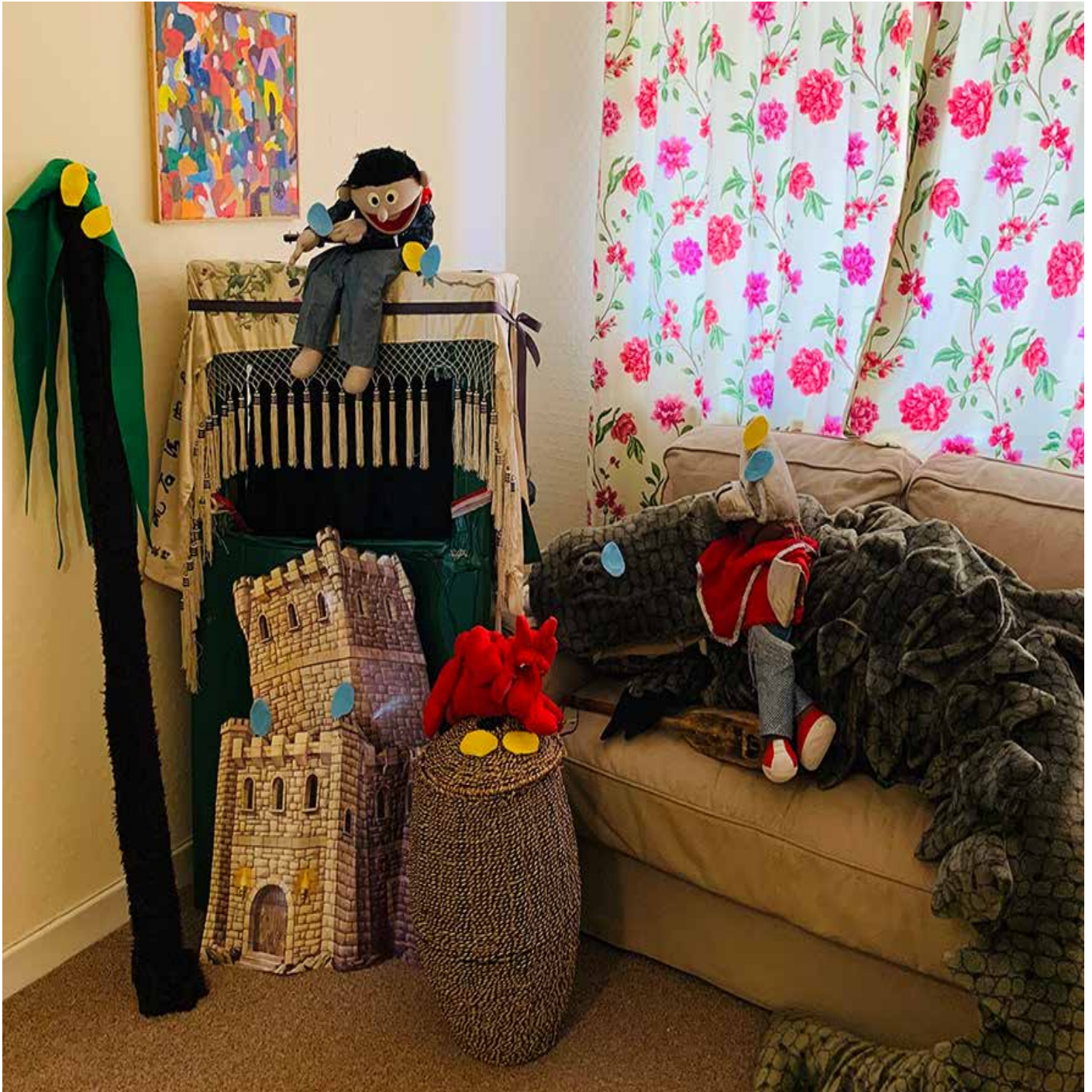

King Arthur is helping to find the dragons' Easter eggs.
Can you help him find all twelve of the eggs in this picture?



recipes

Enjoy making some of these yummy treats with very few ingredients and can all be made without leaving your home.

A LIFE OF OPPORTUNITY
EST.1954

Taurus Crafts, Lydney, GL15 6BU - 01594 844841
www.tauruscrafts.co.uk - enquire@tauruscrafts.co.uk

   @tauruscrafts #tauruscrafts



easy oat biscuits



Ingredients (makes 10-15)

- 75g wholemeal flour
- 1 tsp baking powder
- 75g porridge oats
- 50g caster sugar
- 75g butter
- 1 tbsp golden syrup
- 2 tbsp milk

Method

1. Heat the oven to 180C/fan 160C/gas 4. Line a baking tray with baking parchment.
2. Sift flour into a bowl. Mix in baking powder, porridge oats and sugar.
3. Melt the butter, syrup and milk in a small saucepan or in the microwave and stir.
4. Add to the dry ingredients. Mix until the liquid covers all the oat mixture and until well combined.
5. Spoon onto a baking tray and shape into rounds, leaving space between each biscuit as they will spread whilst cooking.
6. Bake for 10 to 15 mins, or until golden brown. Leave to cool for 5 mins before removing from tray.

“nothing beats homemade biscuits, they're perfect served with a glass of milk, juice or a hot chocolate”

unicorn poo meringues



Ingredients (makes approx 22)

4 Large egg whites, at room temperature

100g caster sugar

100g icing sugar

4 food colouring gels or pastes of choice

Small amount of black fondant for the smiley face features

Method

1. Heat oven to 120C/100C fan/gas mark 1/2
2. Line 2 baking sheets with greaseproof paper.
3. Using a 4cm round biscuit cutter as a guide, draw 22 circles on each piece of parchment using a pencil. Turn the parchment over and use this as a guide to pipe your meringues onto.
4. Whip up the egg whites using an electric hand mixer until they form stiff peaks.
5. Gradually add the caster sugar, a tbsp at a time, whisking continuously between each addition.
6. Repeat with the icing sugar and continue to mix until the mixture is glossy and stiff.
7. Put the piping bag in a tall glass or jug with the thin open end at the base and wide open end at the top. Place the star nozzle inside so that it fits snugly in the thin end of the bag. Roll the wide open end over the top of your tall glass or jug.
8. Paint a thin stripe of each coloured food gel or paste from the nozzle, all the way up to the top of your piping bag.
9. Spoon in the meringue mixture.
10. Pipe swirls of meringue onto the trays using the circles as a guide.
11. Bake in the oven for 20 minutes.
12. Then turn the oven temperature down to 100c/80fan/gas 1/4 . Cook for a further hour or until the meringues are completely cooked through and sound hollow when tapped on the base.
13. Leave to cool on the oven.
14. Mould tiny pieces of the black fondant to create eyes and mouths.
15. Stick these to your cooled meringues with a small dab of water icing.

raspberry and honey flapjacks



Ingredients (makes 9-12)

150g butter
150g light soft brown sugar
300g porridge oats
100g frozen raspberries

Method

1. Heat the oven to 200C/180C fan/gas mark 6.
2. Line your 20cm x 20cm baking tin with greaseproof paper.
3. Melt your butter, sugar, honey and a pinch of salt in a saucepan.
4. Once the mixture is bubbling and evenly combined, stir in the oats.
5. Tip the mixture into the lined baking tin and press down with the back of your wooden spoon
6. Scatter over the frozen raspberries, then lightly press into the oat mixture.
7. Bake for 25-30 minutes until golden brown.
8. Leave to cool then cut into 9 or 12 flapjacks



nature activities

Get some fresh air by having a go
at these nature inspired activities
without leaving your garden.

A LIFE OF OPPORTUNITY
EST.1954

Taurus Crafts, Lydney, GL15 6BU - 01594 844841
www.tauruscrafts.co.uk - enquire@tauruscrafts.co.uk

   [@tauruscrafts](https://www.instagram.com/tauruscrafts) [#tauruscrafts](https://www.facebook.com/tauruscrafts)



bird spotting

See how many birds you can spot in your garden.
Use this checklist and images of different birds.

Black Bird



Goldfinch

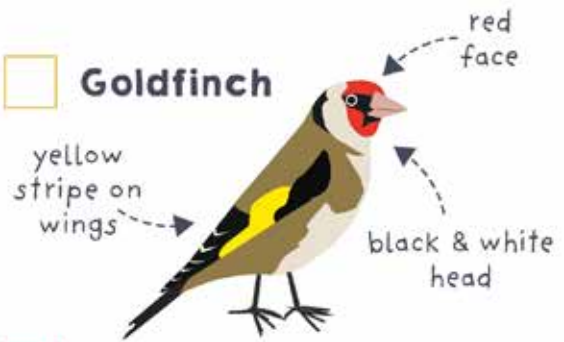

Blue Tit



Robin



Chaffinch

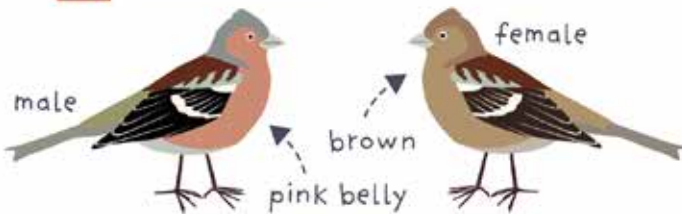

Great Tit



Collared Dove

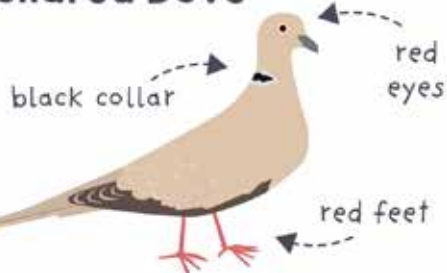

House Sparrow



Wood Pigeon

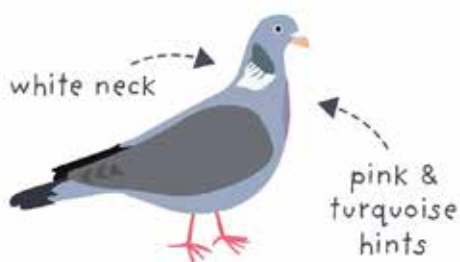

Starling



nature pictures



How to complete the picture puzzles

1. Collect flowers, sticks, grass, leaves, stems, rocks, seeds and more from your garden.
2. Print and colour the bunny faces, rainbow and tree. (on the following pages).
3. Display your nature finds on the table so that your children can see all the materials available to them.
4. Place the glue (optional) and the printables on the table.
5. Get creative. decorate the printable over and over (don't use glue) or use glue to create an artwork to display.
6. Display them around your house when completely dry.
7. Repeat as many times as you want, by printing more sheets or drawing your own designs.

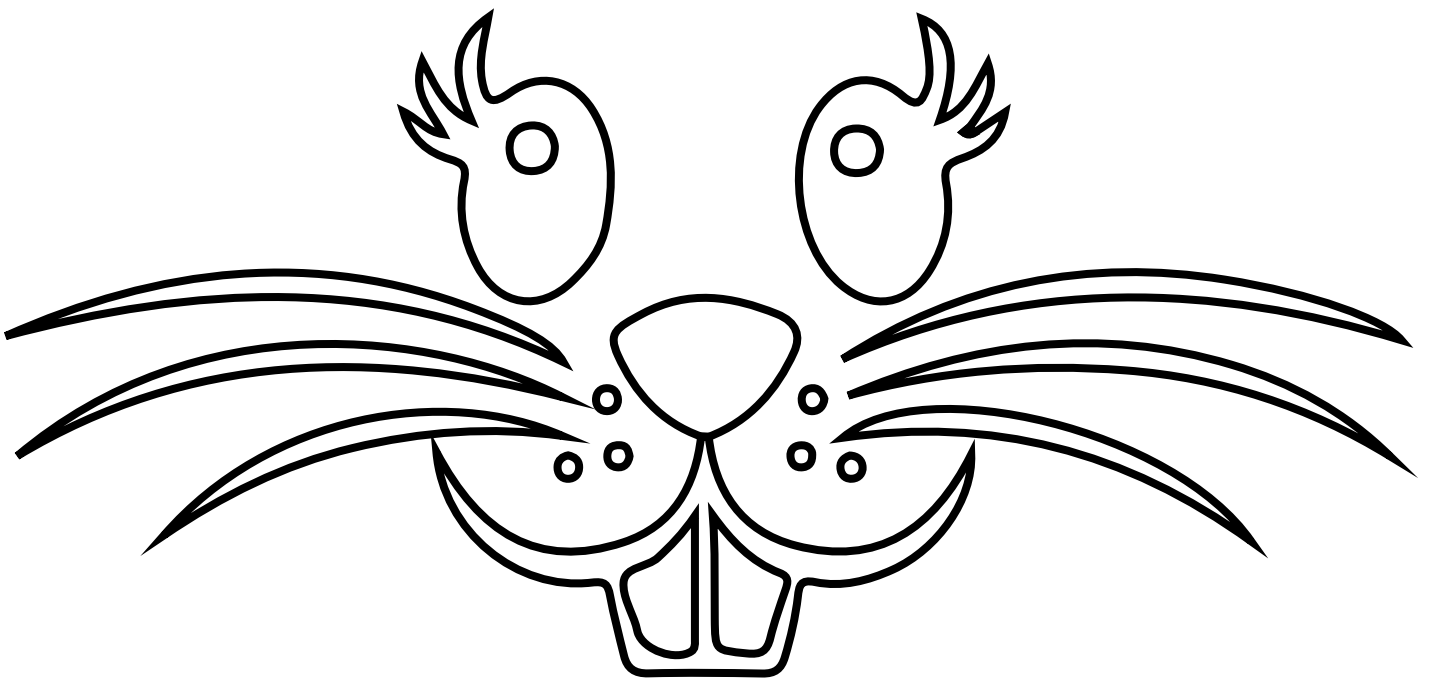

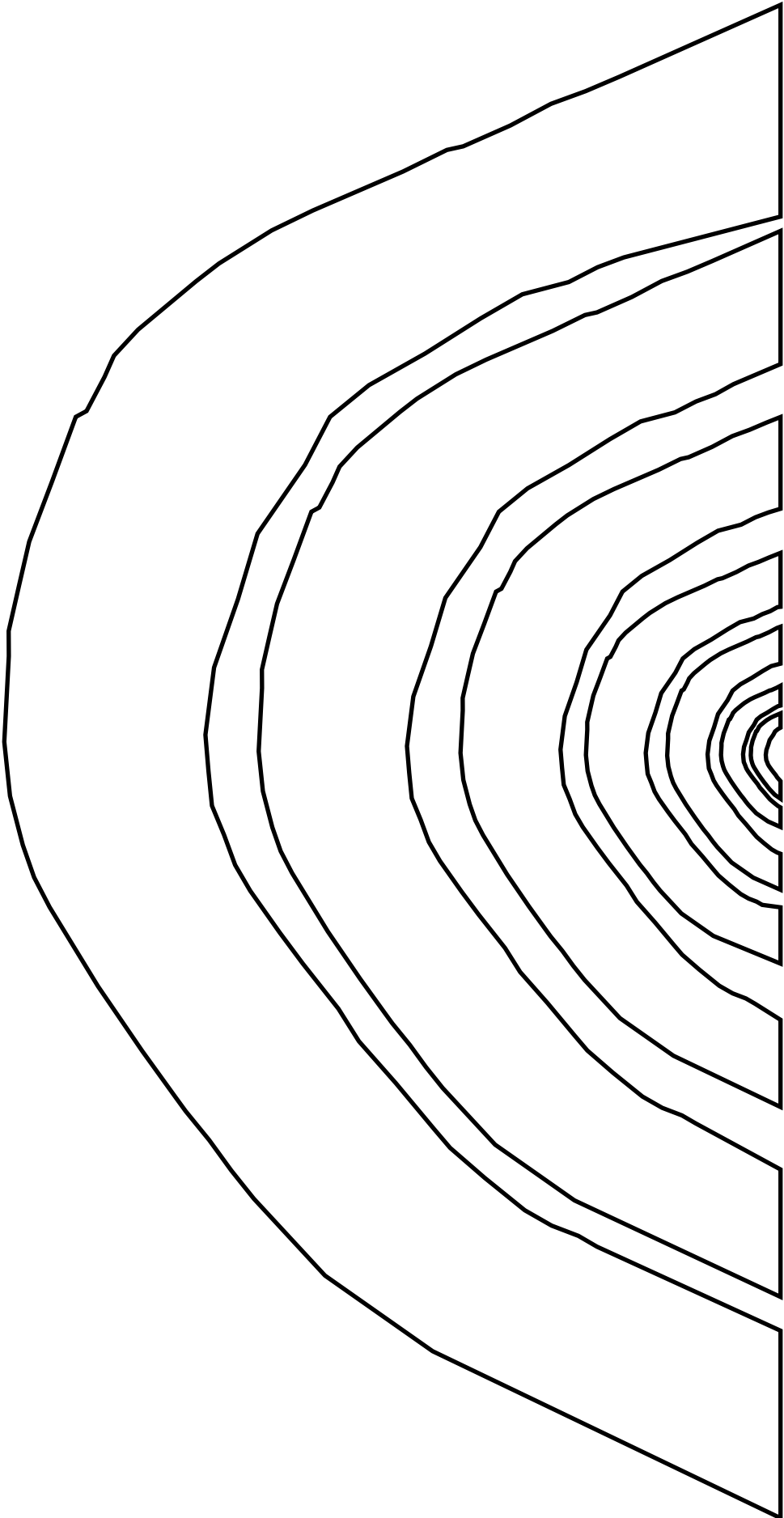

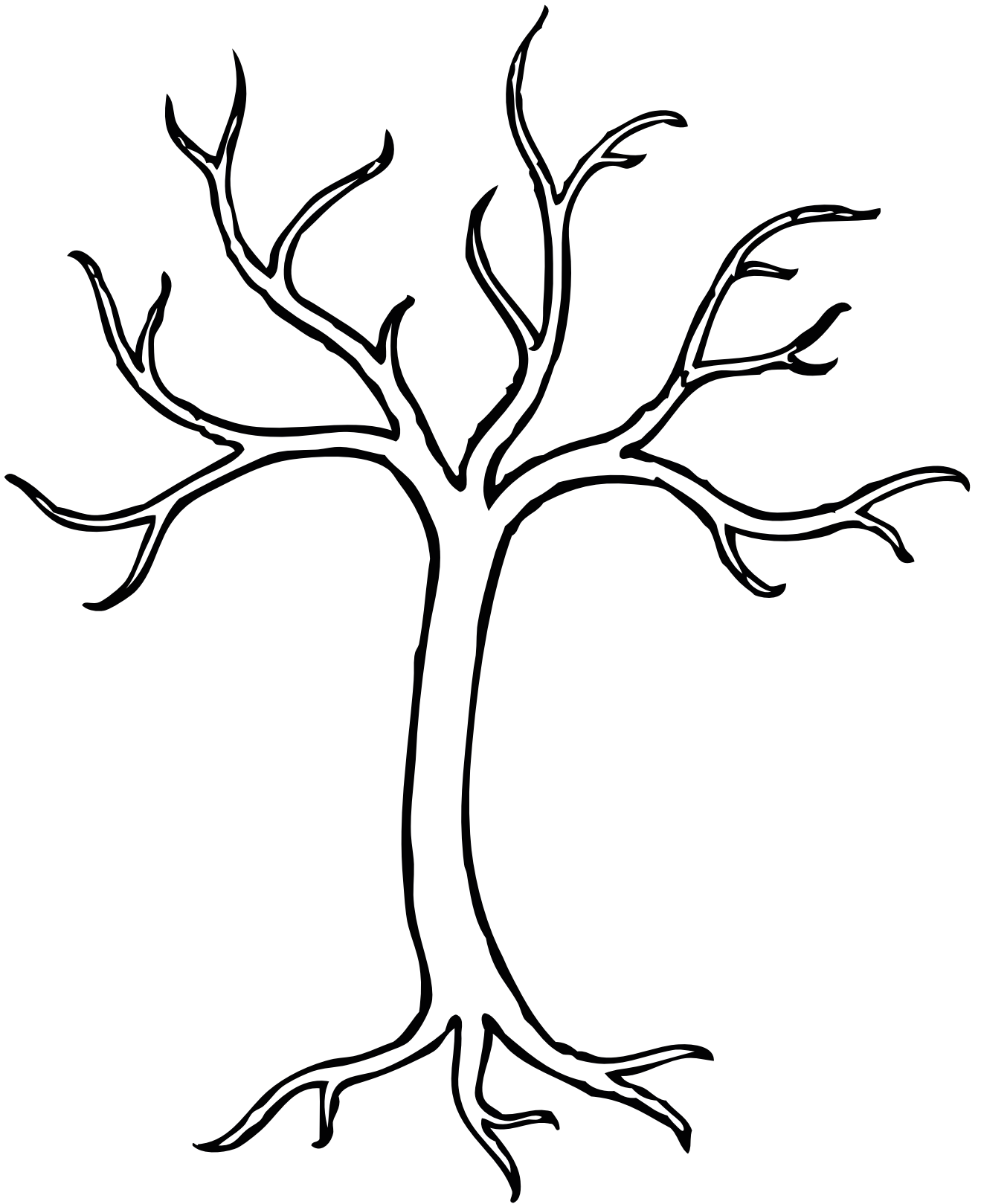



camphill
village
trust

TAURUS CRAFTS

paper plane

Follow these simple instructions to
create your own paper plane.

A LIFE OF OPPORTUNITY
EST.1954

Taurus Crafts, Lydney, GL15 6BU - 01594 844841
www.tauruscrafts.co.uk - enquire@tauruscrafts.co.uk

   @tauruscrafts #tauruscrafts



paper plane

1. First colour in the patterns on the piece of paper on the opposite page, or design your own.
2. Then follow these instructions, folding along the dotted lines.

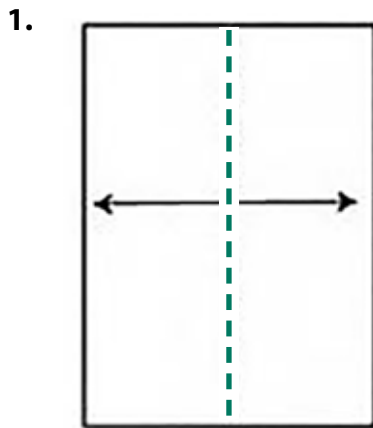

Fold piece of paper in half

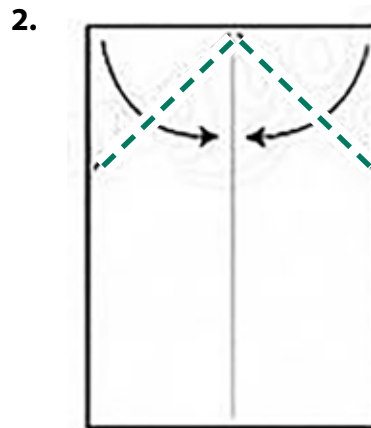

Unfold paper and fold in the top two corners

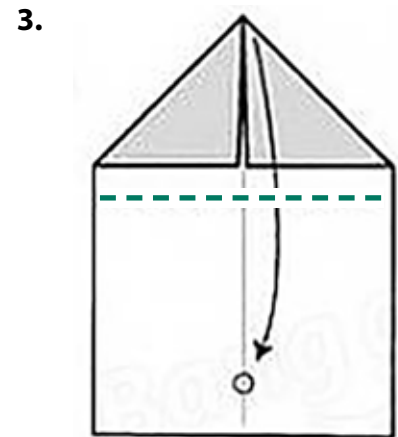

Take the top point and fold over. About 1-2cm from bottom edge.

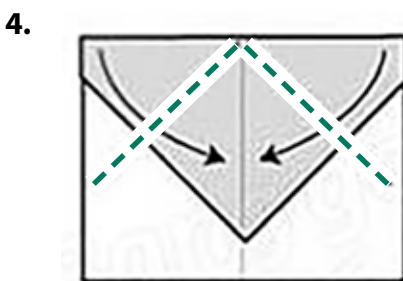

Fold the top two corners of the paper into the middle

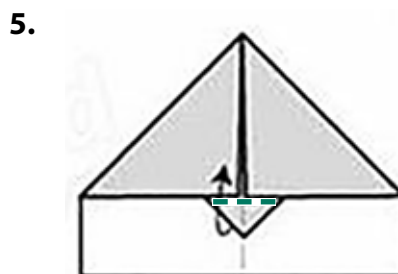

Fold small triangle point up

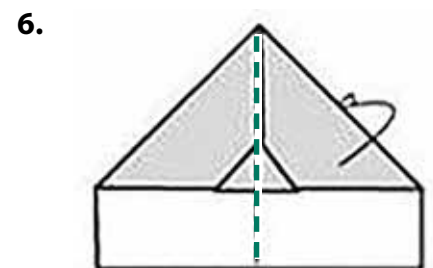

Fold paper in half, away from you

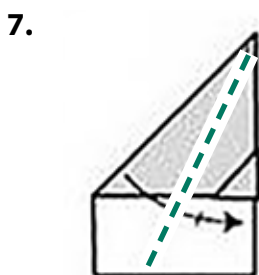

Fold to make wings

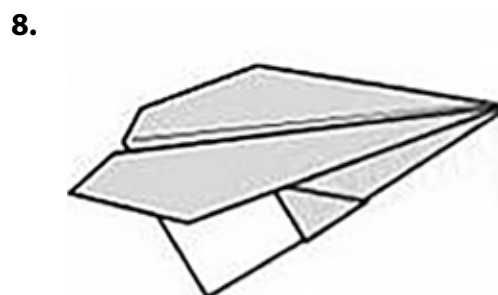

Now fly your plane

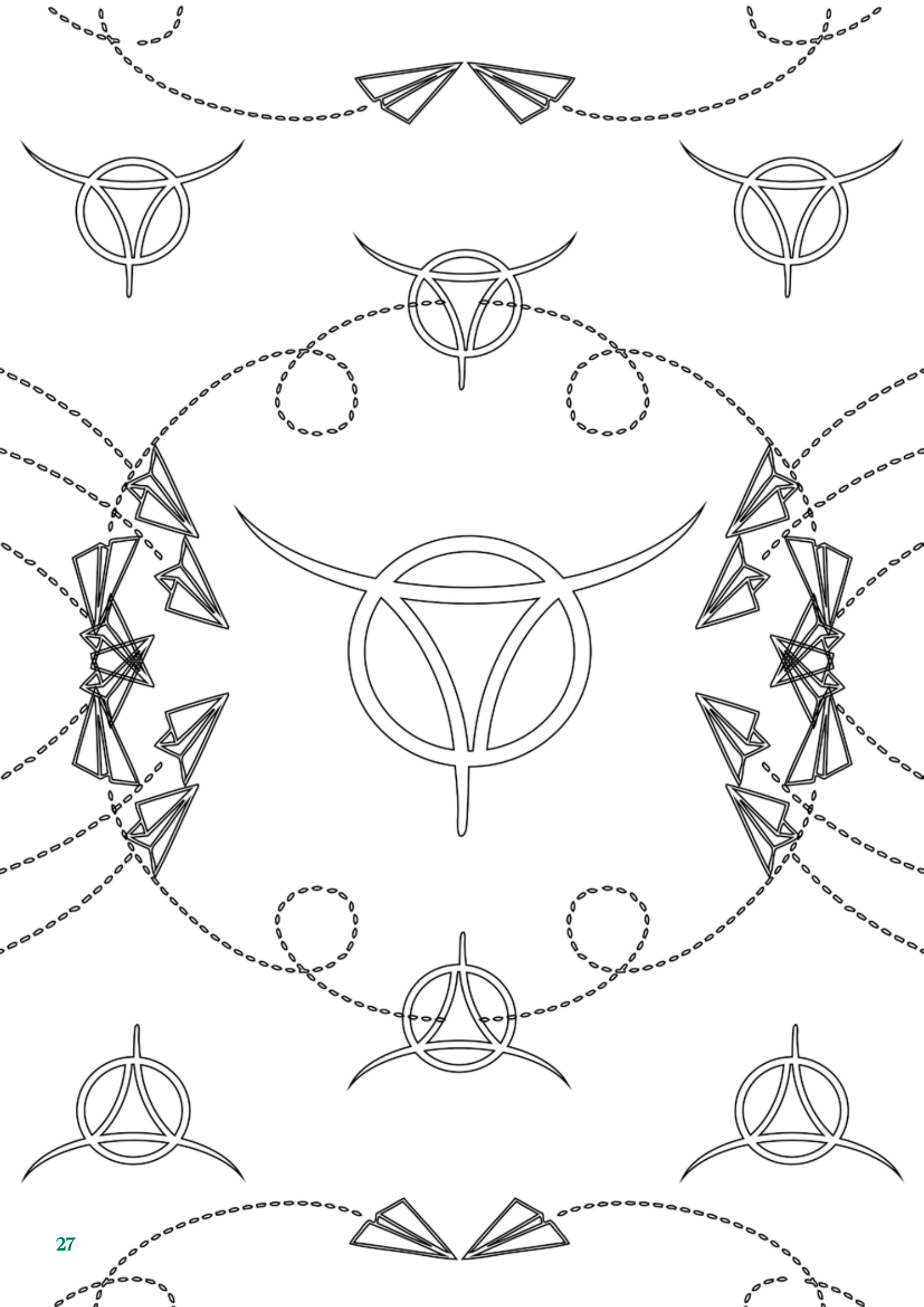



answers

A LIFE OF OPPORTUNITY
EST.1954

Taurus Crafts, Lydney, GL15 6BU - 01594 844841
www.tauruscrafts.co.uk - enquire@tauruscrafts.co.uk

   @tauruscrafts #tauruscrafts



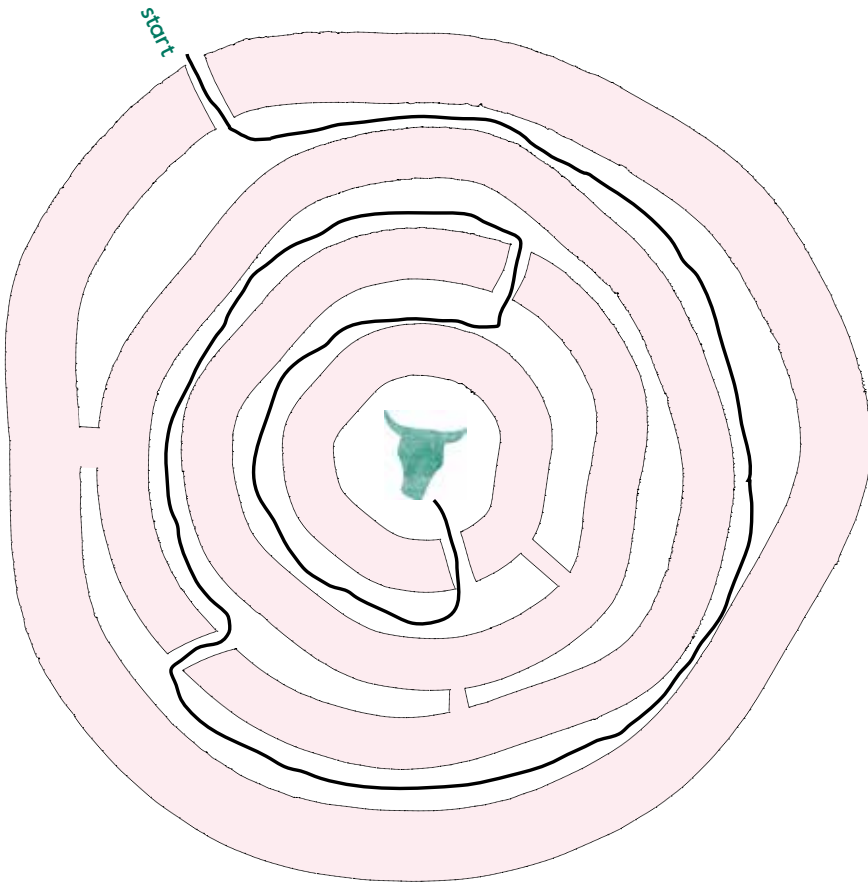







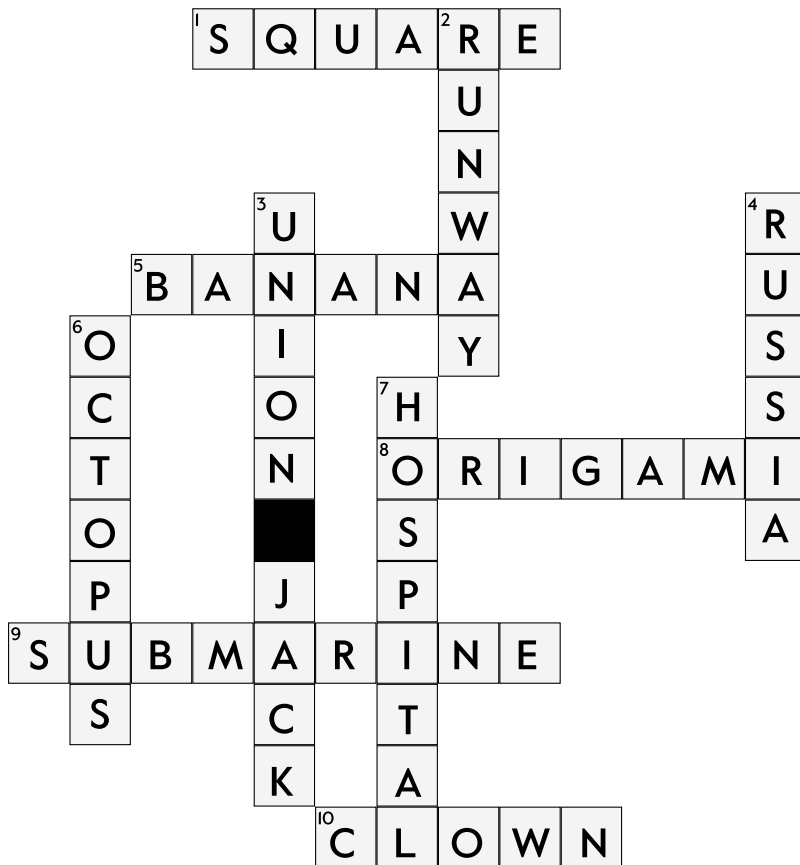





















taurus maze
page 3

c	e	s	u	p	p	o	r	t	u	h	m	j	s
a	e	o	l	o	u	r	f	e	p	k	a	r	t
m	a	z	e	t	q	a	i	y	j	l	r	e	o
p	a	m	c	t	v	i	n	e	e	w	y	t	n
h	c	a	a	e	s	n	g	n	w	o	r	h	e
i	r	k	u	r	l	b	w	t	e	k	o	i	c
l	a	e	j	y	u	o	b	u	l	t	s	c	a
l	f	r	e	e	w	q	k	l	v	e	a	r	
d	t	g	l	a	s	s	f	o	e	k	u	l	y
c	s	g	k	u	w	c	h	a	r	i	t	y	i
i	l	g	r	e	e	k	o	m	y	t	h	d	n
t	h	u	x	c	h	e	c	o	l	a	t	e	g
z	a	d	e	i	k	g	i	f	t	s	h	o	p
t	s	v	i	b	r	a	n	t	p	k	b	i	m

word-search
page 8



crossword puzzle
page 9

1 = 	 +  = 7
2 = 	 +  = 12
3 = 	 +  = 17
4 = 	 +  = 8
5 = 	 +  = 12
6 = 	 +  = 6
7 = 	 +  = 10
8 = 	 +  = 8
9 = 	 +  = 6

colour code maths
page 10

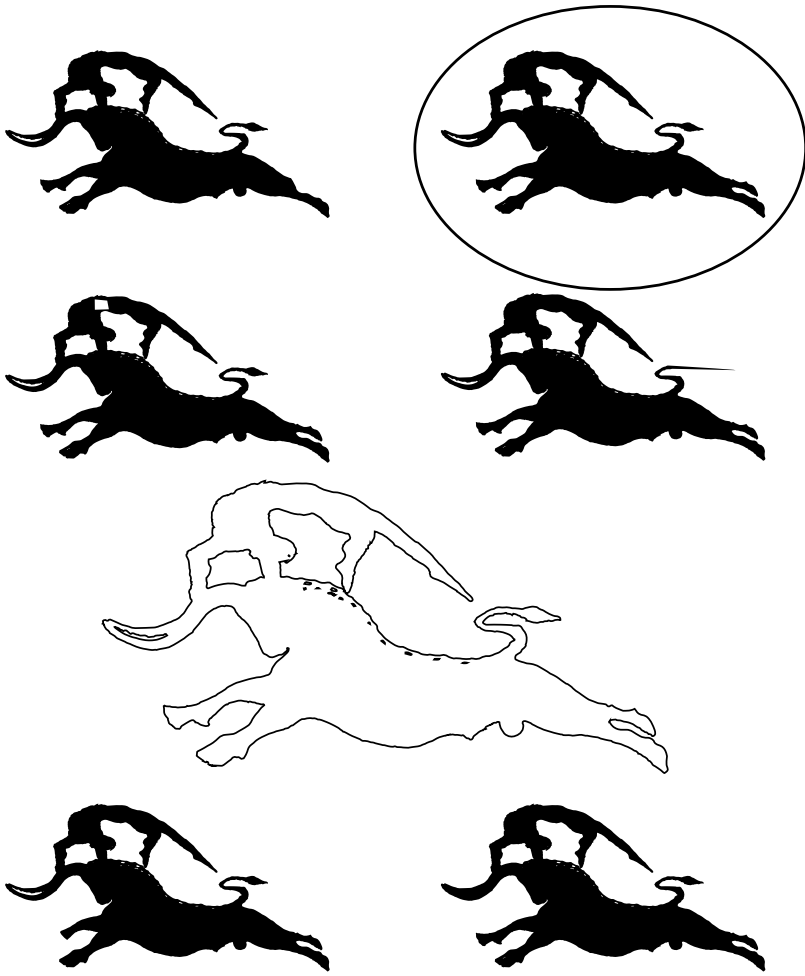

silhouettes
page 11



lost butterflies
page 13

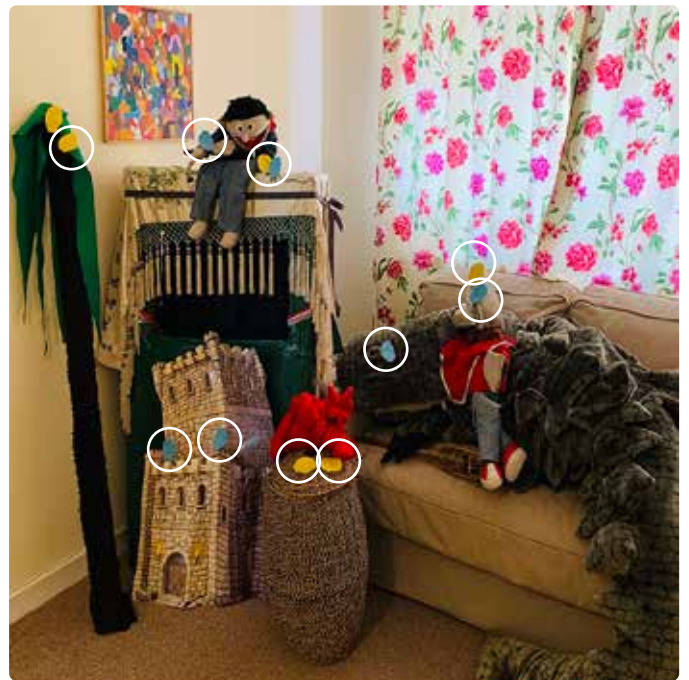

find the eggs
page 14